

Netz-Thyristor
Phase Control Thyristor
T1930N
Vorläufige Daten
preliminary data
Elektrische Eigenschaften / Electrical properties
 Höchstzulässige Werte / Maximum rated values

Periodische Vorwärts- und Rückwärts-Spitzensperrspannung repetitive peak forward off-state and reverse voltages	$T_{vj} = -40^{\circ}\text{C} \dots T_{vj \max}$	$V_{\text{DRM}}, V_{\text{RRM}}$	3200 3400	3600 3800	V V
Vorwärts-Stosspitzensperrspannung non-repetitive peak forward off-state voltage	$T_{vj} = -40^{\circ}\text{C} \dots T_{vj \max}$	V_{DSM}	3200 3400	3600 3800	V V
Rückwärts-Stosspitzensperrspannung non-repetitive peak reverse voltage	$T_{vj} = +25^{\circ}\text{C} \dots T_{vj \max}$	V_{RSM}	3300 3500	3700 3900	V V
Durchlassstrom-Grenzeffektivwert maximum RMS on-state current		I_{TRMSM}		4200	A
Dauergrenzstrom average on-state current	$T_{\text{C}} = 85^{\circ}\text{C}$	I_{TAVM}		2180	A
Dauergrenzstrom average on-state current	$T_{\text{C}} = 55^{\circ}\text{C}, \theta = 180^{\circ}\sin, t_{\text{p}} = 10 \text{ ms}$	I_{TAVM}		3140	A
Durchlaßstrom-Effektivwert RMS on-state current		I_{TRMS}		4920	A
Stossstrom-Grenzwert surge current	$T_{vj} = 25^{\circ}\text{C}, t_{\text{p}} = 10 \text{ ms}$ $T_{vj} = T_{vj \max}, t_{\text{p}} = 10 \text{ ms}$	I_{TSM}		40000 37000	A A
Grenzlastintegral I^2t -value	$T_{vj} = 25^{\circ}\text{C}, t_{\text{p}} = 10 \text{ ms}$ $T_{vj} = T_{vj \max}, t_{\text{p}} = 10 \text{ ms}$	I^2t		8000 6850	$10^3 \text{ A}^2\text{s}$ $10^3 \text{ A}^2\text{s}$
Kritische Stromsteilheit critical rate of rise of on-state current	DIN IEC 60747-6 $f = 50 \text{ Hz}, i_{\text{GM}} = 1,6\text{A},$ $di_{\text{G}}/dt = 1,6 \text{ A}/\mu\text{s}$	$(di_{\text{T}}/dt)_{\text{cr}}$		150	$\text{A}/\mu\text{s}$
Kritische Spannungssteilheit critical rate of rise of off-state voltage	$T_{vj} = T_{vj \max}, V_{\text{D}} = 0,67 V_{\text{DRM}}$ 5.Kennbuchstabe / 5 th letter F	$(dv_{\text{D}}/dt)_{\text{cr}}$		1000	$\text{V}/\mu\text{s}$

Charakteristische Werte / Characteristic values

Durchlassspannung on-state voltage	$T_{vj} = T_{vj \max}, i_{\text{T}} = 8 \text{ kA}$ $T_{vj} = T_{vj \max}, i_{\text{T}} = 2 \text{ kA}$	v_{T}	max. max.	2,90 1,60	V V
Schleusenspannung threshold voltage	$T_{vj} = T_{vj \max}$	$V_{(\text{TO})}$		1,08	V
Ersatzwiderstand slope resistance	$T_{vj} = T_{vj \max}$	r_{T}		0,20	$\text{m}\Omega$
Durchlasskennlinie on-state characteristic $1000 \text{ A} \leq i_{\text{T}} \leq 11000 \text{ A}$ $v_{\text{T}} = A + B \cdot i_{\text{T}} + C \cdot \ln(i_{\text{T}} + 1) + D \cdot \sqrt{i_{\text{T}}}$	$T_{vj} = T_{vj \max}$	A= B= C= D=		2,085E+00 7,262E-05 -2,440E-01 2,706E-02	
Zündstrom gate trigger current	$T_{vj} = 25^{\circ}\text{C}, V_{\text{D}} = 12\text{V}$	I_{GT}	max.	300	mA
Zündspannung gate trigger voltage	$T_{vj} = 25^{\circ}\text{C}, V_{\text{D}} = 12\text{V}$	V_{GT}	max.	3	V
Nicht zündender Steuerstrom gate non-trigger current	$T_{vj} = T_{vj \max}, V_{\text{D}} = 12\text{V}$ $T_{vj} = T_{vj \max}, V_{\text{D}} = 0,5 V_{\text{DRM}}$	I_{GD}	max. max.	10 5	mA mA
Nicht zündende Steuerspannung gate non-trigger voltage	$T_{vj} = T_{vj \max}, V_{\text{D}} = 0,5 V_{\text{DRM}}$	V_{GD}	max.	0,25	V
Haltestrom holding current	$T_{vj} = 25^{\circ}\text{C}, V_{\text{D}} = 12\text{V}$	I_{H}	max.	300	mA
Einraststrom latching current	$T_{vj} = 25^{\circ}\text{C}, V_{\text{D}} = 12\text{V}, R_{\text{GK}} \geq 10 \Omega$ $i_{\text{GM}} = 1,6 \text{ A}, di_{\text{G}}/dt = 1,6 \text{ A}/\mu\text{s},$ $t_{\text{g}} = 20 \mu\text{s}$	I_{L}	max.	1500	mA
Vorwärts- und Rückwärts-Sperrstrom forward off-state and reverse current	$T_{vj} = T_{vj \max}$ $V_{\text{D}} = V_{\text{DRM}}, V_{\text{R}} = V_{\text{RRM}}$	$i_{\text{D}}, i_{\text{R}}$	max.	300	mA
Zündverzug gate controlled delay time	DIN IEC 60747-6 $T_{vj} = 25^{\circ}\text{C}, i_{\text{GM}} = 1,6 \text{ A},$ $di_{\text{G}}/dt = 1,6 \text{ A}/\mu\text{s}$	t_{gd}	max.	3	μs

prepared by:	H.Sandmann	date of publication:	2008-03-06
approved by:	J.Przybilla	revision:	1.3

Netz-Thyristor
Phase Control Thyristor
T1930N
Vorläufige Daten
preliminary data
Elektrische Eigenschaften / Electrical properties
 Charakteristische Werte / Characteristic values

Freiwerdezeit circuit commutated turn-off time	$T_{vj} = T_{vj\ max}$, $i_{TM} = I_{TAVM}$ $V_{RM} = 100\ V$, $V_{DM} = 0,67\ V_{DRM}$ $dv_D/dt = 20\ V/\mu s$, $-di_T/dt = 10\ A/\mu s$ 4.Kennbuchstabe / 4 th letter O	t_q	typ. 450	μs
---	--	-------	----------	---------

Thermische Eigenschaften / Thermal properties

Innerer Wärmewiderstand thermal resistance, junction to case	<u>Kühlfläche / cooling surface</u> beidseitig / two-sided, $\theta = 180^\circ\ sin$ beidseitig / two-sided, DC Anode / anode, $\theta = 180^\circ\ sin$ Anode / anode, DC Kathode / cathode, $\theta = 180^\circ\ sin$ Kathode / cathode, DC	R_{thJC}	max. 0,0085 max. 0,0078 max. 0,0152 max. 0,0146 max. 0,0183 max. 0,0169	$^\circ C/W$ $^\circ C/W$ $^\circ C/W$ $^\circ C/W$ $^\circ C/W$ $^\circ C/W$
Übergangs-Wärmewiderstand thermal resistance, case to heatsink	<u>Kühlfläche / cooling surface</u> beidseitig / two-sides einseitig / single-sides	R_{thCH}	max. 0,0025 max. 0,0050	$^\circ C/W$ $^\circ C/W$
Höchstzulässige Sperrschichttemperatur maximum junction temperature		$T_{vj\ max}$	125	$^\circ C$
Betriebstemperatur operating temperature		$T_{c\ op}$	-40...+125	$^\circ C$
Lagertemperatur storage temperature		T_{stg}	-40...+150	$^\circ C$

Mechanische Eigenschaften / Mechanical properties

Gehäuse, siehe Anlage case, see annex			Seite 3 page 3	
Si-Element mit Druckkontakt Si-pellet with pressure contact				
Anpresskraft clamping force		F	42...95	kN
Steueranschlüsse control terminals	Gate (flat) Gate (round, based on AMP 60598) Kathode / cathode		A 2,8x0,5 \varnothing 1,5 A 4,8x0,5	mm mm mm
Gewicht weight		G	typ. 1200	g
Kriechstrecke creepage distance			25	mm
Schwingfestigkeit vibration resistance	f = 50 Hz		50	m/s ²

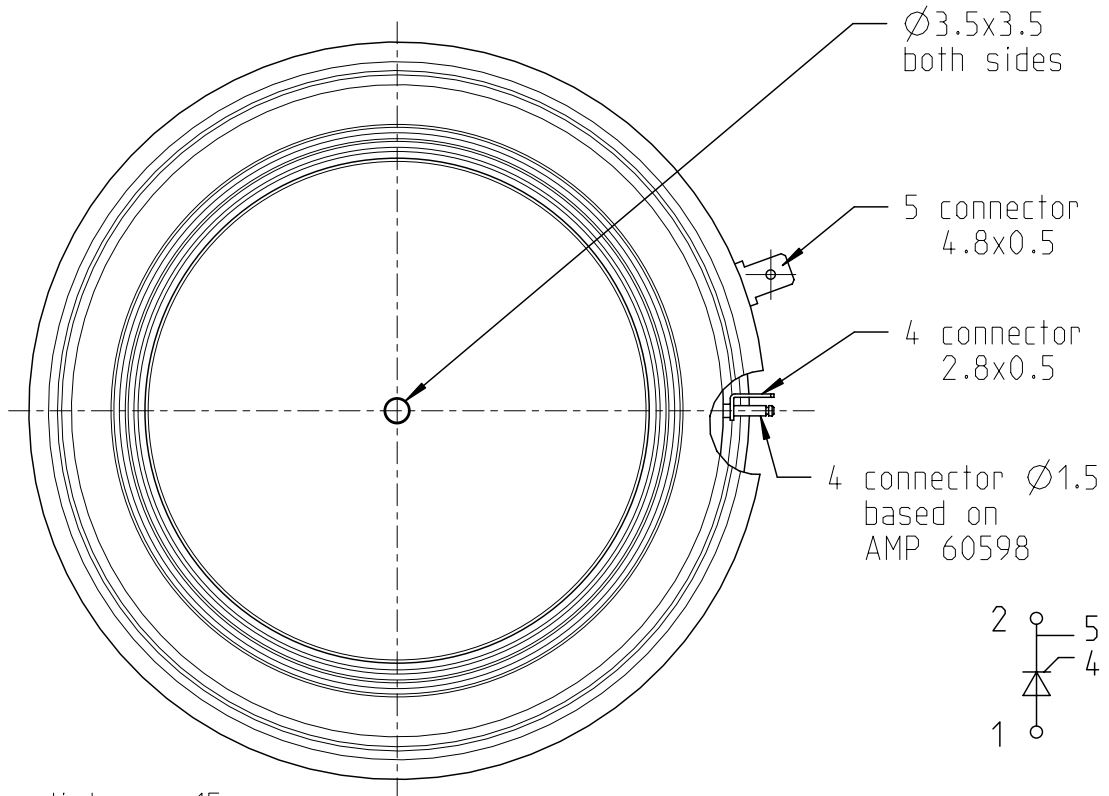
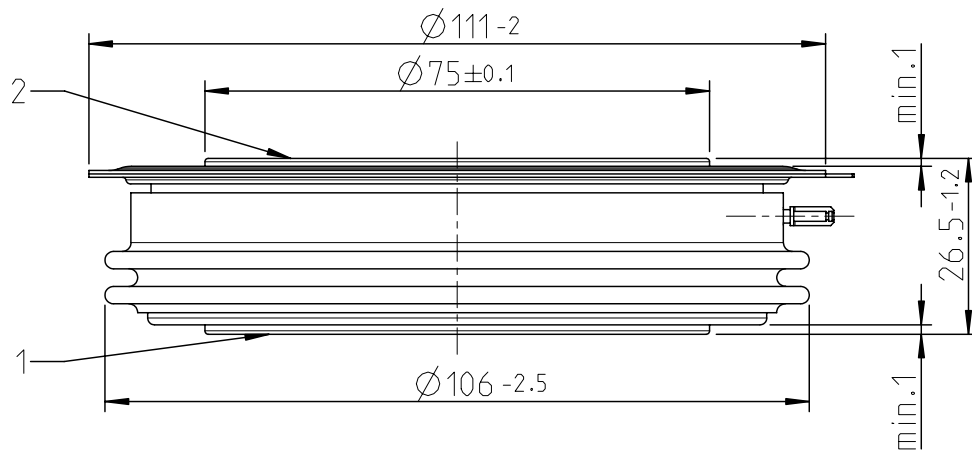
N**Datenblatt / Data sheet**
Netz-Thyristor
Phase Control Thyristor
T1930N
Vorläufige Daten
preliminary data

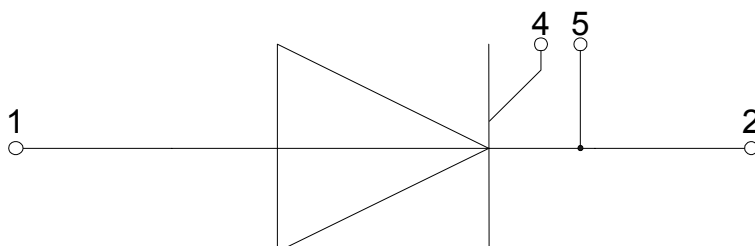
 strike distance: 15mm
 creepage distance: 25mm

 overall height based
 on contact pressure
**1: Anode / Anode****2: Kathode / Cathode****4: Gate****5: Hilfskathode/
Auxiliary Cathode**

Analytische Elemente des transienten Wärmewiderstandes Z_{thJC} für DC
Analytical elements of transient thermal impedance Z_{thJC} for DC

Kühlung / Cooling	Pos. n	1	2	3	4	5	6	7
beidseitig two-sided	R_{thn} [°C/W]	0,00003	0,00039	0,00123	0,00280	0,00338	-	-
	τ_n [s]	0,00006	0,00392	0,01520	0,20680	1,09140	-	-
anodenseitig anode-sided	R_{thn} [°C/W]	0,00001	0,00037	0,00190	0,00130	0,00434	0,00668	-
	τ_n [s]	0,00001	0,00182	0,00951	0,13500	0,34700	1,54000	-
kathodenseitig cathode-sided	R_{thn} [°C/W]	0,00003	0,00073	0,00302	0,00802	0,00510	-	-
	τ_n [s]	0,00004	0,00341	0,02150	0,13500	1,11000	-	-

Analytische Funktion / Analytical function:

$$Z_{thJC} = \sum_{n=1}^{n_{max}} R_{thn} \left(1 - e^{-\frac{t}{\tau_n}} \right)$$

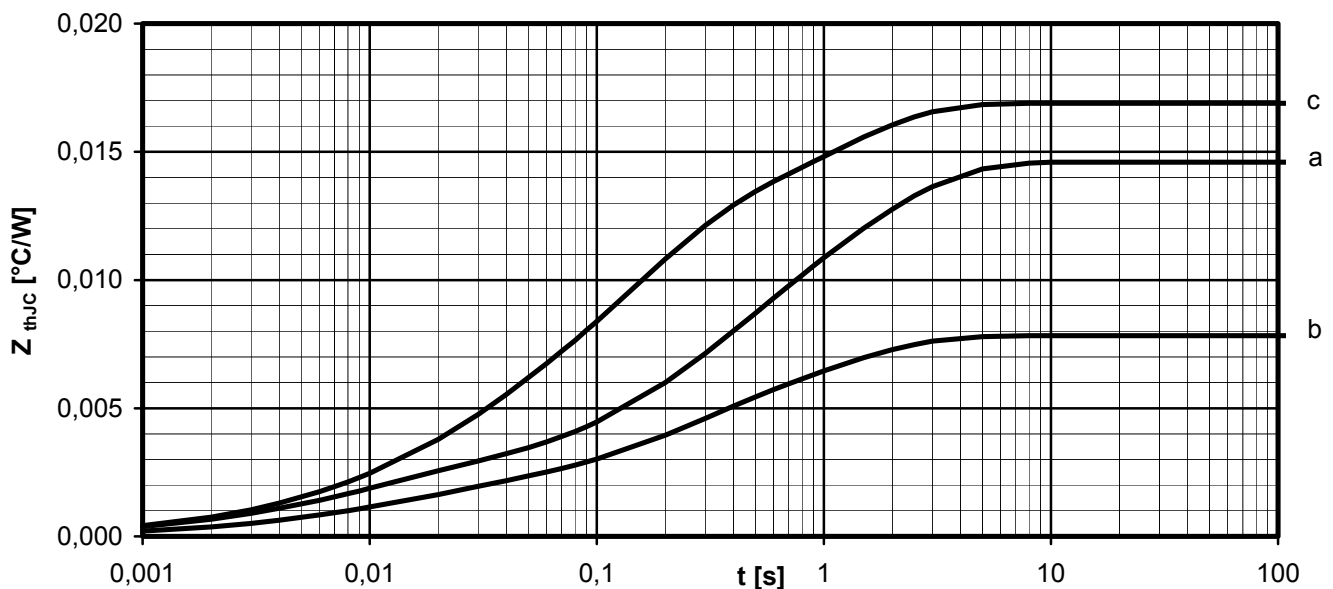
Transienter innerer Wärmewiderstand für DC / Transient thermal impedance for DC
 $Z_{thJC} = f(t)$

- a - Anodenseitige Kühlung / Anode-sided cooling
- b - Beidseitige Kühlung / Two-sided cooling
- c - Kathodenseitige Kühlung / Cathode-sided cooling

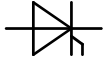

Netz-Thyristor
Phase Control Thyristor

T1930N

Vorläufige Daten
preliminary data

Erhöhung des $Z_{th DC}$ bei Sinus und Rechteckströmen mit unterschiedlichen Stromflusswinkeln Θ
Rise of $Z_{th DC}$ for sinewave and rectangular current with different current conduction angles Θ

$\Delta Z_{th \Theta rec} / \Delta Z_{th \Theta sin}$

Kühlung / Cooling		$\Theta = 180^\circ$	$\Theta = 120^\circ$	$\Theta = 90^\circ$	$\Theta = 60^\circ$	$\Theta = 30^\circ$
beidseitig two-sided	$\Delta Z_{th \Theta rec}$ [°C/W]	0,00084	0,00000	0,00161	0,00201	0,00259
	$\Delta Z_{th \Theta sin}$ [°C/W]	0,00069	0,00093	0,00120	0,00156	0,00208
anodenseitig anode-sided	$\Delta Z_{th \Theta rec}$ [°C/W]	0,00143	0,00228	0,00288	0,00371	0,00492
	$\Delta Z_{th \Theta sin}$ [°C/W]	0,00112	0,00154	0,00208	0,00289	0,00425
kathodenseitig cathode-sided	$\Delta Z_{th \Theta rec}$ [°C/W]	0,00170	0,00261	0,00322	0,00399	0,00506
	$\Delta Z_{th \Theta sin}$ [°C/W]	0,00144	0,00191	0,00246	0,00321	0,00430

$$Z_{th \Theta rec} = Z_{th DC} + \Delta Z_{th \Theta rec}$$

$$Z_{th \Theta sin} = Z_{th DC} + \Delta Z_{th \Theta sin}$$

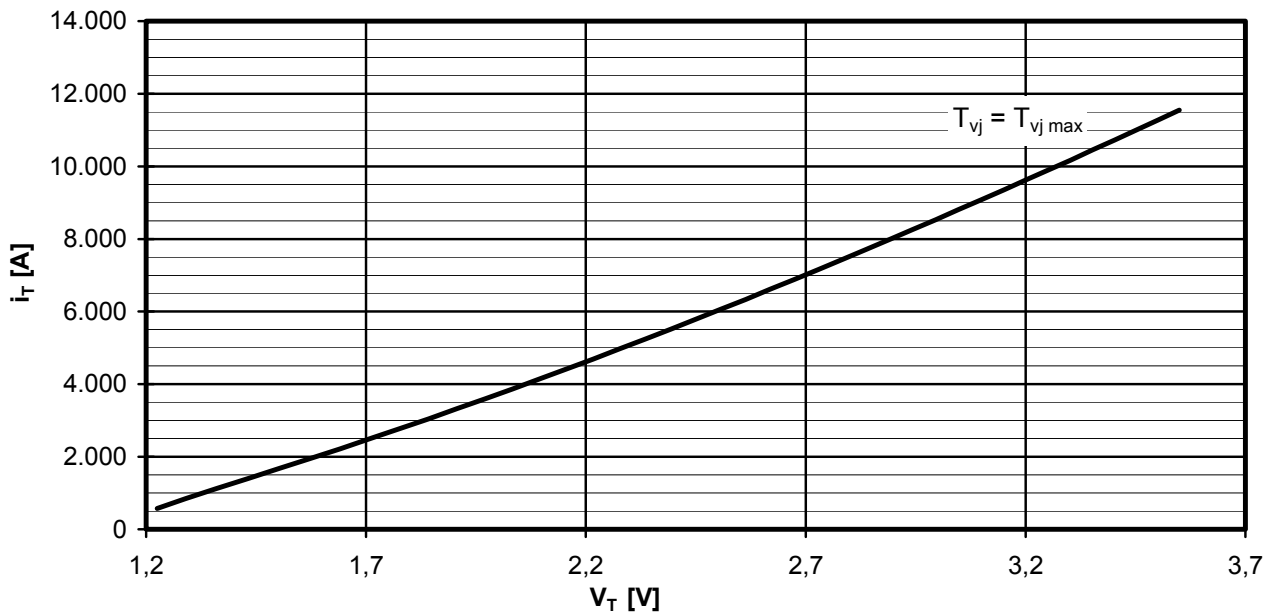

Grenzdurchlasskennlinie / Limiting on-state characteristic $i_T = f(V_T)$

$$T_{vj} = T_{vj max}$$



Netz-Thyristor
Phase Control Thyristor

T1930N

Vorläufige Daten
preliminary data

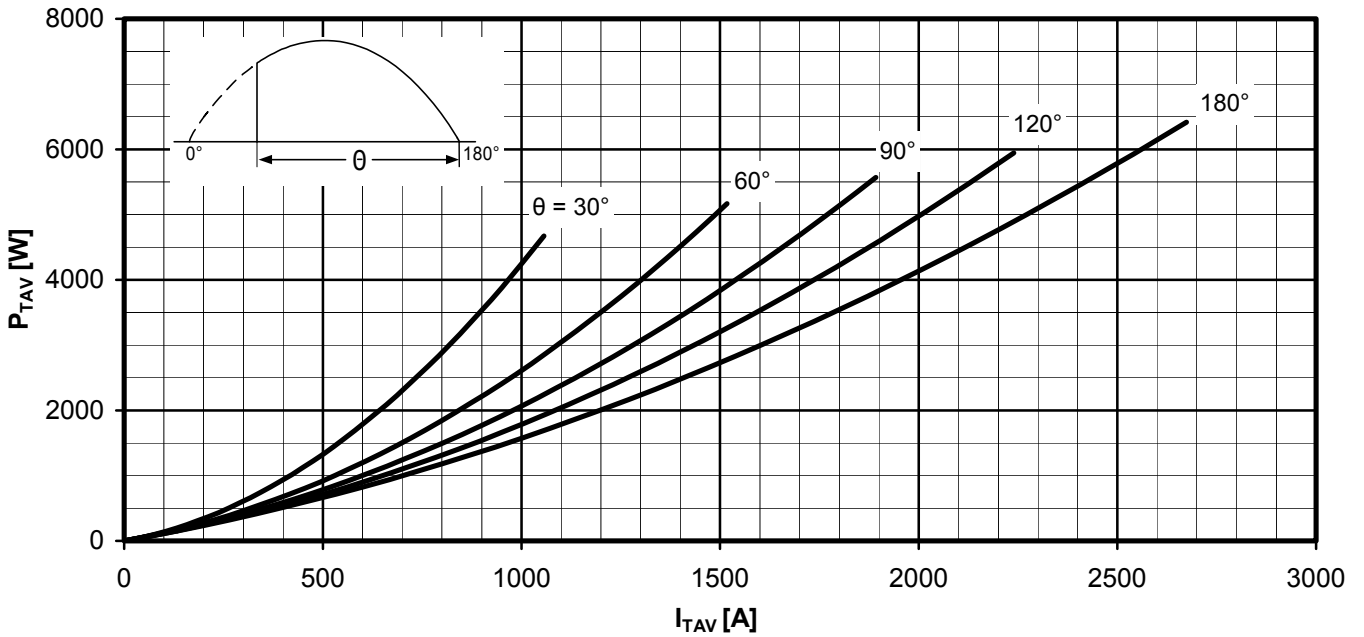

Durchlassverlustleistung / On-state power loss $P_{TAV} = f(I_{TAV})$

Sinusförmiger Strom / Sinusoidal current

Parameter: Stromflusswinkel Θ / Current conduction angle Θ

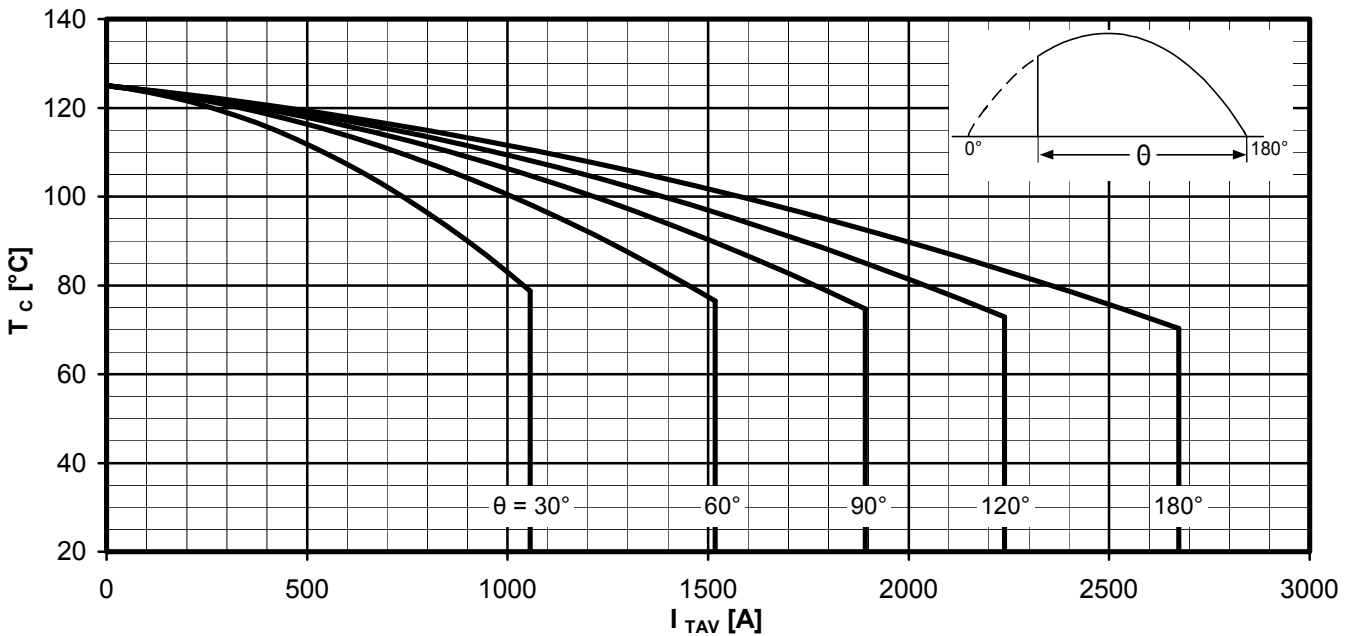

Höchstzulässige Gehäusetemperatur / Maximum allowable case temperature $T_c = f(I_{TAV})$

Sinusförmiger Strom / Sinusoidal current

Beidseitige Kühlung / Two-sided cooling

Parameter: Stromflusswinkel Θ / Current conduction angle Θ

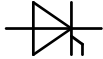

Netz-Thyristor
Phase Control Thyristor

T1930N

Vorläufige Daten
preliminary data

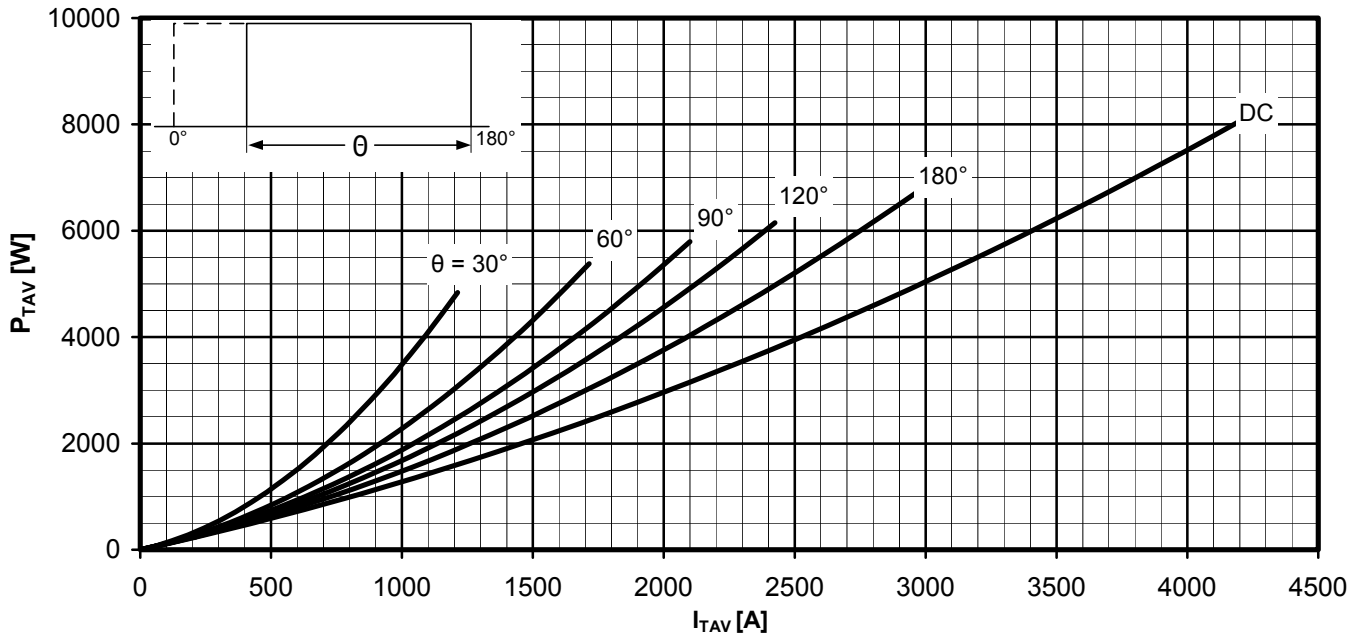

Durchlassverlustleistung / On-state power loss $P_{TAV} = f(I_{TAV})$

Rechteckförmiger Strom / Rectangular current

Parameter: Stromflusswinkel Θ / Current conduction angle Θ

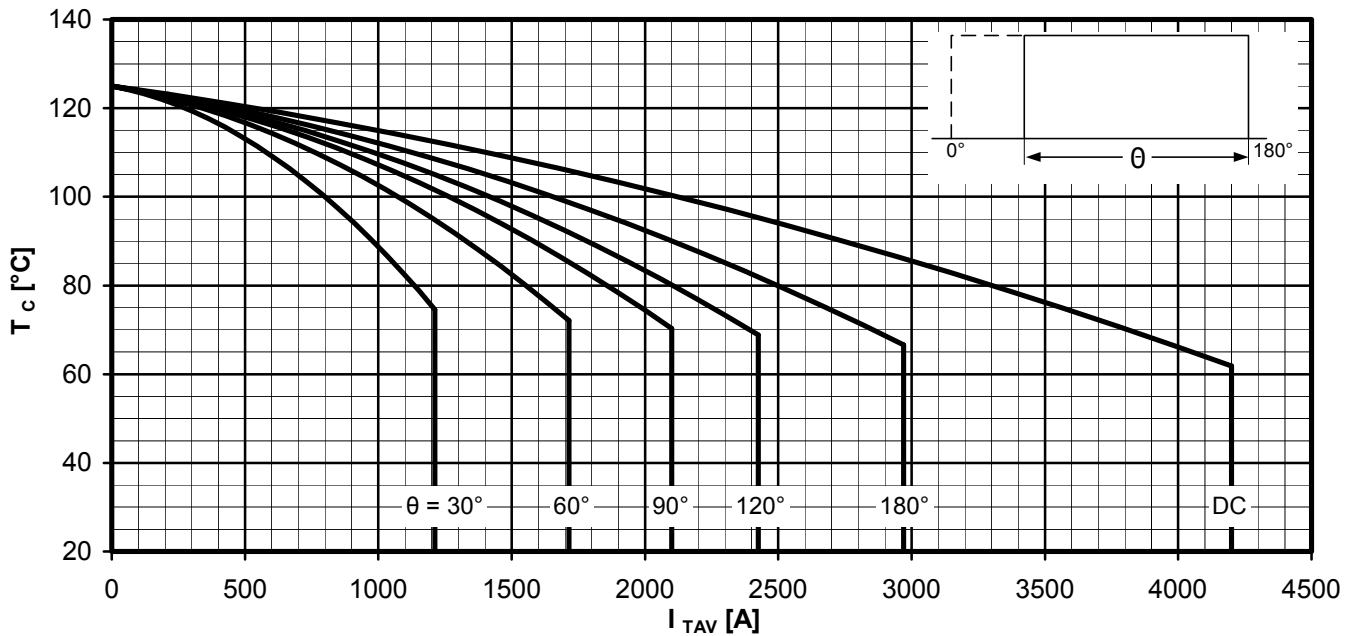

Höchstzulässige Gehäusetemperatur / Maximum allowable case temperature $T_c = f(I_{TAV})$

Rechteckförmiger Strom / Rectangular current

Beidseitige Kühlung / Two-sided cooling

Parameter: Stromflusswinkel Θ / Current conduction angle Θ



Netz-Thyristor
Phase Control Thyristor

T1930N

Vorläufige Daten
preliminary data

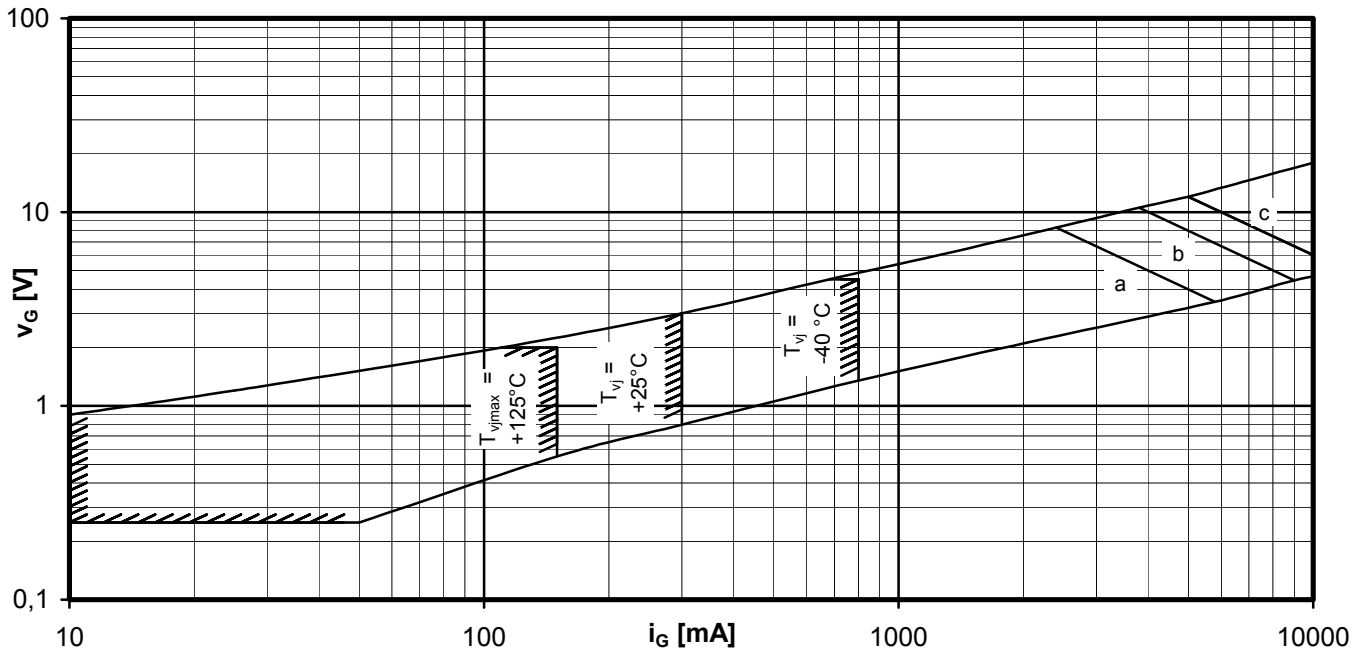

Steuercharakteristik $v_G = f(i_G)$ mit Zündbereichen für $V_D = 12\text{ V}$
Gate characteristic $v_G = f(i_G)$ with triggering area for $V_D = 12\text{ V}$

Höchstzulässige Spitzensteuerverlustleistung / Maximum rated peak gate power dissipation $P_{GM} = f(t_g)$:

a - 20W / 10ms b - 40W / 1ms c - 60W / 0,5ms

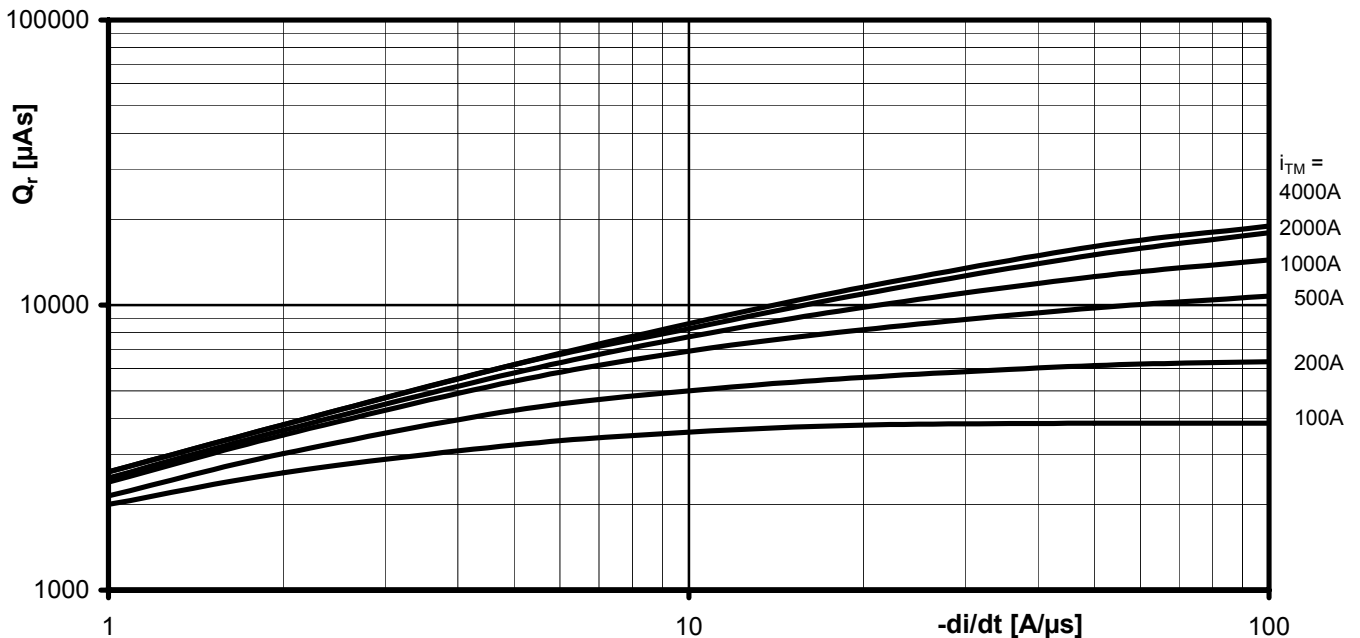

Sperrverzögerungsladung / Recovered charge $Q_r = f(di/dt)$

$T_{vj} = T_{vjmax}$, $V_R \leq 0,5 V_{RRM}$, $V_{RM} = 0,8 V_{RRM}$

Parameter: Durchlassstrom / On-state current i_{TM}



Netz-Thyristor
Phase Control Thyristor

T1930N

Vorläufige Daten
preliminary data

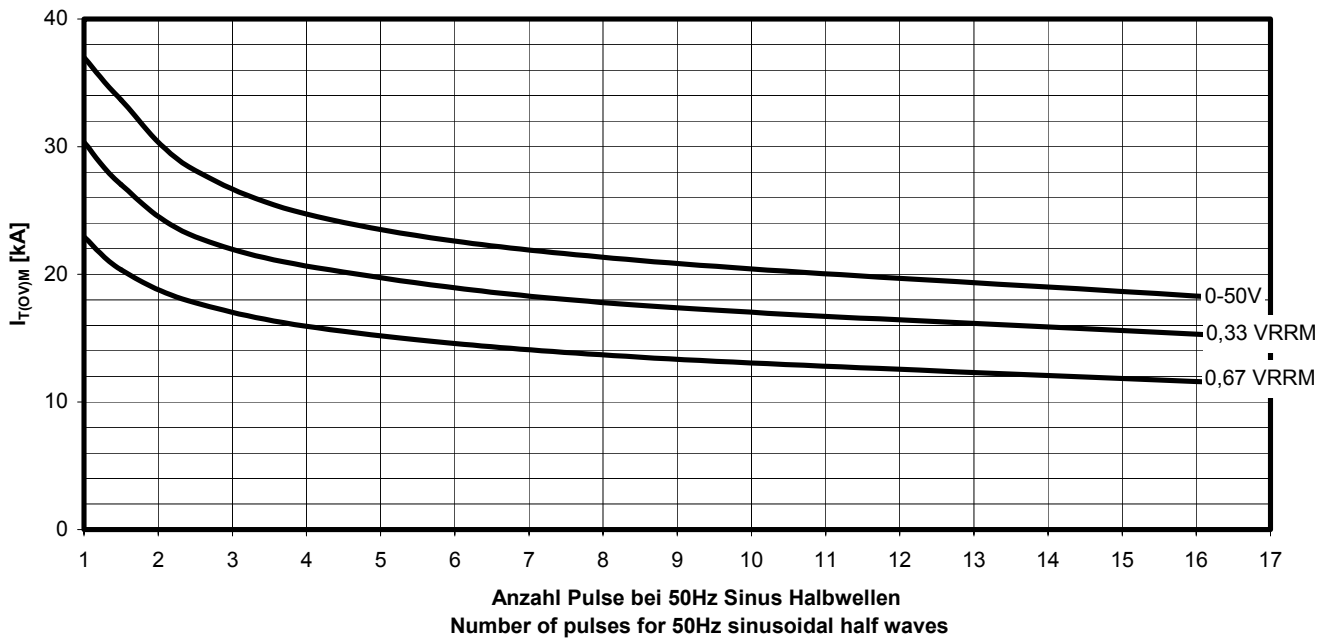

Typische Abhängigkeit des Grenzstromes $I_{T(OV)M}$ von der Anzahl für eine Folge von Sinus
Halbwellen bei 50Hz. Parameter: Rückwärtsspannung V_{RM}
 Typical dependency of maximum overload on-state current $I_{T(OV)M}$ as a number of a sequence of
 sinusoidal half waves at 50Hz. Parameter: peak reverse voltage V_{RM}
 $I_{T(OV)M} = f(\text{pulses}, V_{RM}) ; T_{vj} = T_{vjmax}$